

Instruction Manual
High accuracy
Handheld Thermometer

HRM-120E

First edition (Jan. 2024)

AE-100301

Anritsu Meter Co., Ltd.



2-4-5 Shimomeguro, Meguro-ku, Tokyo, 153-0064, Japan

TEL: +81-3-3491-9181

FAX: +81-3-3493-6729

Safety information

Caution

To safely operate and service the thermometer and to prevent any product damage and/or maintain the precise temperature measurement results, please carefully follow the instructions below:

- Do not use this product for any purpose other than taking temperature measurements.
- If any abnormalities are found, immediately stop using the product.
- Do not disassemble or modify the product.
- Do not use any power supply other than commercially available dry batteries and/or a dedicated adaptor.
- Insert the batteries in the correct manner (pole+ to pole+).
- Remove the batteries when depleted or when the product is not expected to be used for an extended period of time.
- Do not mix old and new batteries or batteries of different makes or types.

Warning

- Do not throw into an open fire. Do not short circuit, disassemble, or heat.
- Do not recharge the batteries at any time.
- Use specified type batteries.
- To prevent electric shock, do not touch the metal parts or terminals of the sensor cable or output cable during measurement.
- To prevent electric shock, if the sensor is still in contact with the voltage application part even when the power is turned off, disconnect the sensor before setting the output cable or device.
- ※ When measuring under the influence of high voltage and high frequency, there is a risk of electric shock and measurement failure, so please contact us.

Compliance

This product has a built-in reader/writer module that uses radio waves with a transmission frequency of 13.56 MHz.

Compliance with NCC Rules

 CCAQ23LP0671T2

『取得審驗證明之低功率射頻器材,非經核准,公司、商號或使用者均不得擅自變更頻率、加大功率或變更原設計之特性及功能。

低功率射頻器材之使用不得影響飛航安全及干擾合法通信;經發現有干擾現象時,應立即停用,並改善至無干擾時方得繼續使用。

前述合法通信,指依電信管理法規定作業之無線電通信。

低功率射頻器材須忍受合法通信或工業、科學及醫療用電波輻射性電機設備之干擾。』

Compliance in Japan

Standard number: ARIB STD-T82

Designated type number: FC-20001

This product contains a reader/writer module that is certified with a designated type of radio wave, which is provided by the *Radio Law* of Japan. As a radio wave with a transmission frequency of 13.56 MHz is used, the product.

Introduction

Thank you very much for purchasing this Anritsu Meter product.

This instruction manual has been carefully prepared to ensure that the product can be used safely and securely.

Please carefully and thoroughly read this instruction manual, fully understand all the individual functions, and use the product properly.

Should you have any unclear issues or questions while operating the product, please refer to this instruction manual.

Notes

- The contents of this document and/or product specifications are subject to change without prior notice.
- Unauthorized reproduction of any part of this document is strictly prohibited.
- This instruction manual has been prepared with absolute care. Please free feel to contact our company or your retailer should you discover any omissions or mistakes.
- In no event is Anritsu Meter liable to anyone for any indirect, special, or consequential damages as a result of using this product.

Warranty and After-sales Service

● Warranty

This product has been submitted to strict tests and inspections prior to delivery. Anritsu Meter warrants this product to be free from defects in material and workmanship for a period of one (1) year from date of delivery. Should any failures arise due to defects during manufacture or accidents during transportation, please contact our company or your retailer. For any failures during the warranty period which are deemed our responsibility, we will exchange the necessary parts or carry out repairs at no cost.

However, the warranty will be considered to be voided (i.e., the customer pays for repairs) in the following cases:

- Failure due to a fire, earthquake, or any other force majeure.
- Failure due to misuse, abuse, and/or modification. (Please note that if the case of the product is opened or the screws are loosened, such an act will be regarded as a modification.)

Note: Our thermocouple probes are consumables and are not covered by the warranty.

● **After-sales Service**

- If you think the product is not correctly working, please refer to this instruction manual. Should any issue persist, please contact our company or your retailer.

- Repairs during the warranty period are subject to the content of the warranty sheet. However, only when used in Japan. Repairs after the warranty period has elapsed will be carried out only if such repairs recover and maintain the product functions.

- If there is a need to return the product for repair or calibration, please pack it in the original packaging that was used for delivery. If such packaging is not available, please enclose the product with sufficient cushioning material and return the product in a condition where no damage can be caused.

Table of Contents

1.	General	1
2.	Unpacking	1
2.1.	Unpacking.....	1
2.2.	Repacking	1
3.	Name and Explanation of Each Part	2
3.1.	External View	2
3.2.	LCD Display	3
4.	Preparations Before Taking Measurements	4
4.1.	How to Install the Batteries.....	4
4.2.	How to Use the Hand Strap	4
4.3.	How to Set the Probe.....	5
4.4.	How to Use the Soft Case.....	5
5.	Operations and Functions	6
5.1.	Power ON/OFF	6
5.2.	Automatic correction function.....	6
5.3.	HOLD Function	7
5.4.	Automatic Power OFF Function	7
5.5.	Resolution Change.....	8
5.6.	P/V Hold Function	9
5.7.	Turning the Backlight ON/OFF	9
6.	Retention of Setup Data	10
7.	Checking the Remaining Battery	10
8.	Error Messages	11
8.1.	Indication of a Broken Wire of the Probe.....	11
8.2.	Overrange Indication	11
8.3.	Battery Voltage Drop Indication.....	11
9.	Maintenance	12
9.1.	Storage	12
9.2.	When the Case of the Instrument Gets Dirty.....	12
10.	Troubleshooting: Before Contacting Support	13
11.	HRM-120E Specifications	14

1. General

This product is a handheld thermometer for high accuracy, reliability and usability. Based on the HR Series, this product is highly accurate and supports probes with an IC tag. The IC tag records errors unique to thermocouple probes. By reading the IC tag, errors will be automatically corrected, thereby enabling even higher accuracy measurements.

2. Unpacking

2.1. Unpacking

Please check if the following items are present when unpacking. We make sure all items are carefully packed, but should you find any missing or failed items, please contact our company or your retailer.

Item	Q'ty	Applicable model
Main unit	1	All models
Soft case	1	All models
Hand strap	1	All models
Alkaline AA battery	4	All models
Instruction manual	1	All models
Test report	1	All models
Warranty sheet	1	All models
User registration sheet	1	All models

2.2. Repacking

To move this instrument (such as transportation by car), pack it in its original packaging. If the case is not available, fully protect the instrument with shock-absorbing material (Styrofoam, etc.). Please note that if packing materials generate dust or moisture, the instrument may become damaged. Please use dry packing materials that do not generate dust.

3. Name and Explanation of Each Part

3.1. External View

(HRM-120E)

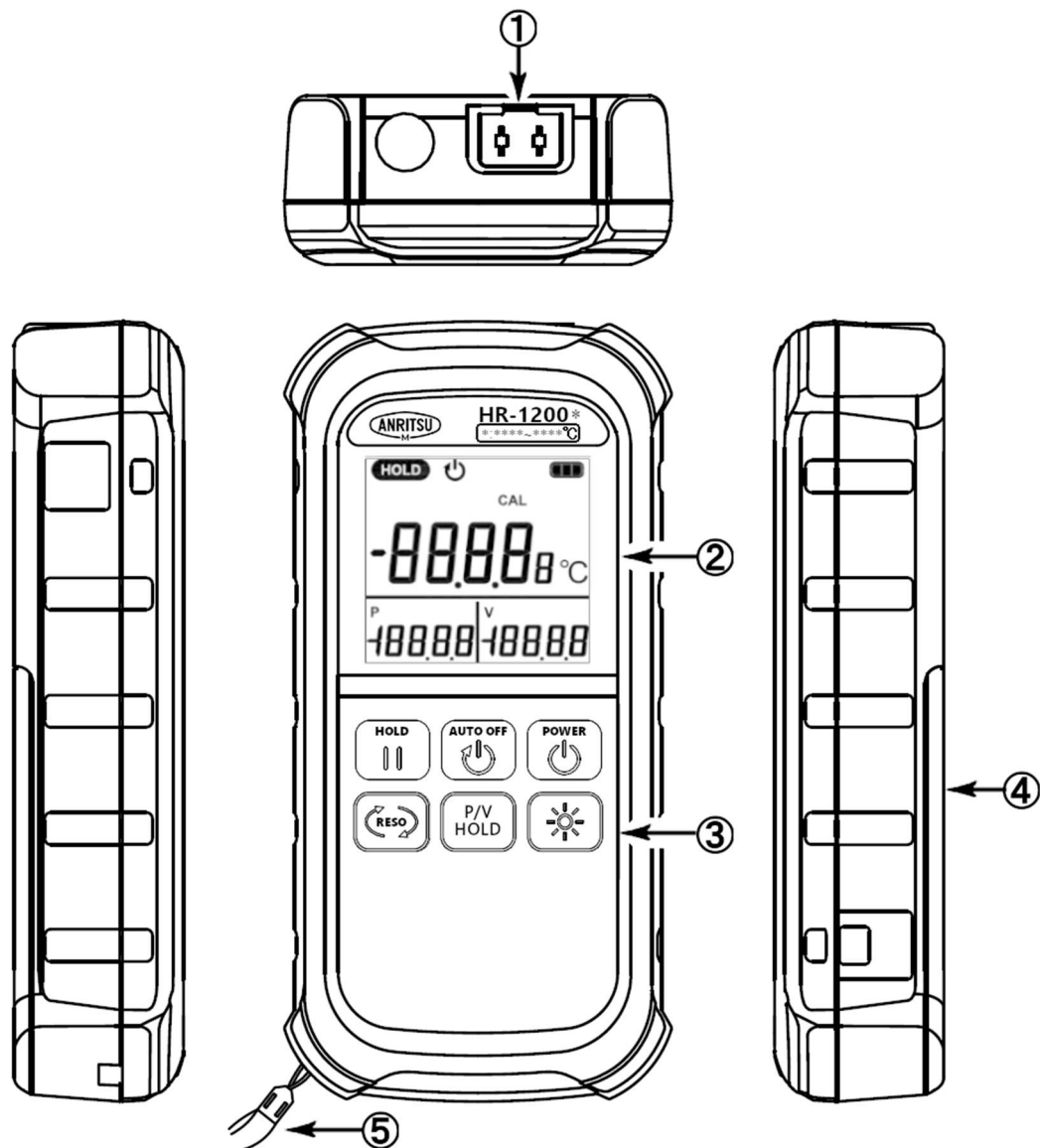

- ① Probe input connector
- ② LCD display
- ③ Key switch panel
- ④ Battery housing
- ⑤ Hand strap

3.2. LCD Display

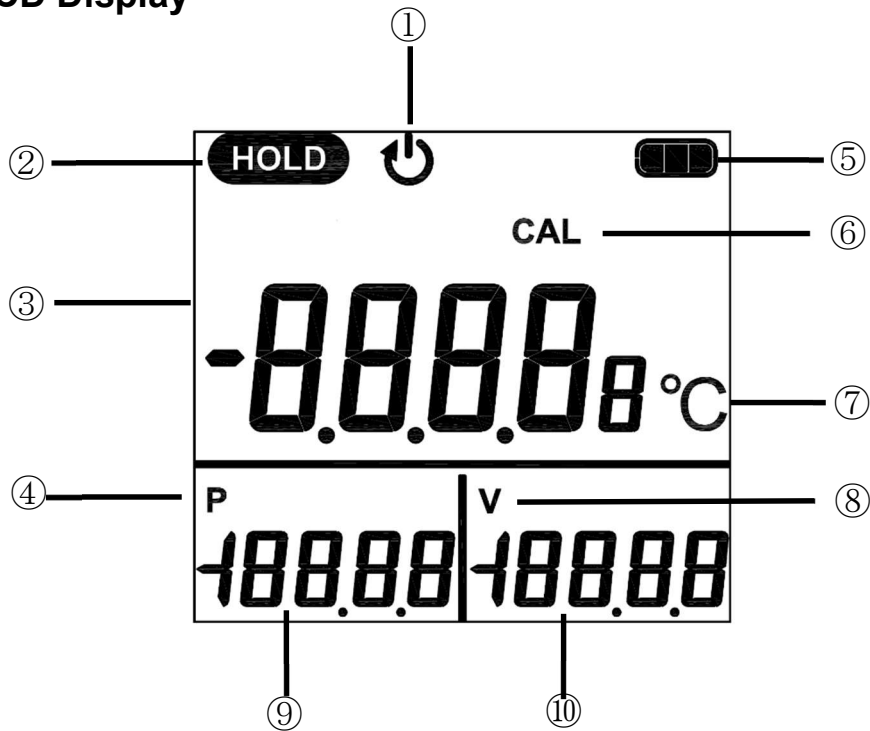

	Description
①	A-OFF segment
②	HOLD segment
③	Main display
④	P segment
⑤	Battery segment
⑥	CAL segment
⑦	°C segment
⑧	V segment
⑨	Sub display 1
⑩	Sub display 2

4. Preparations Before Taking Measurements

4.1. How to Install the Batteries

Make sure to turn the power off when replacing batteries.

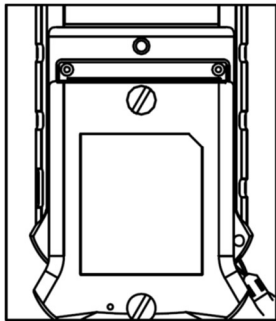

- (1) Loosen both screws and open the cover of the battery housing.

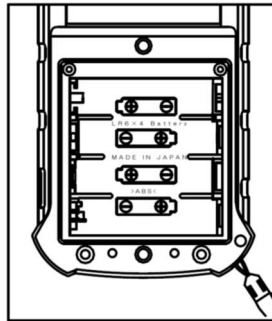

- (2) Pay attention to the orientation of the batteries.

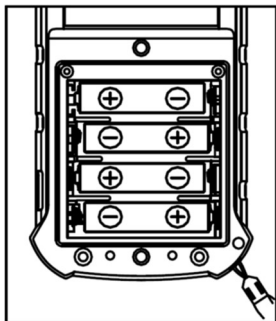

- (3) Install the batteries.

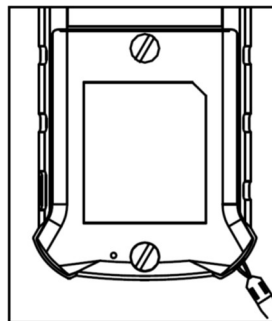

- (4) Reattach the battery housing cover, tighten both screws, and press the edge of the cover to secure it

Note: To maintain the waterproofing performance, firmly tighten the screws on the battery cover.

4.2. How to Use the Hand Strap

Place the enclosed hand strap on your wrist to prevent the instrument from dropping.

Loop the thin cord of the strap through the hole and then pull the other end of the hand strap through that loop.

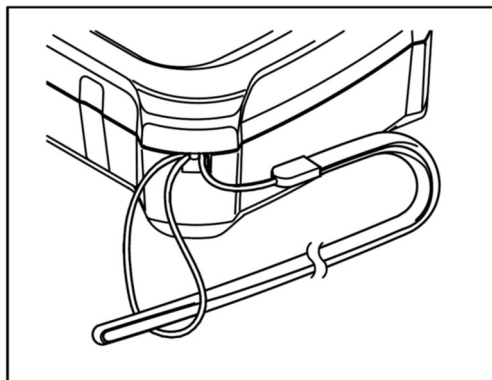

4.3. How to Set the Probe

Set the probe to the main unit as shown in the illustration below. It is designed so that if the probe orientation is incorrect, it cannot be fully inserted. If the probe is forcefully inserted, failure may result. Please check the probe's orientation before inserting it.

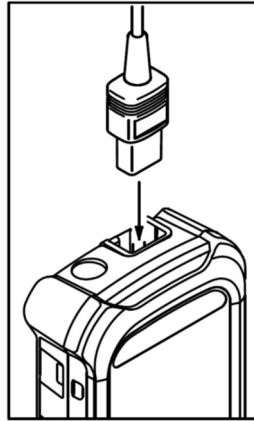

4.4. How to Use the Soft Case

To protect the instrument from dirt or scratches, etc., use the attached soft case. When using an AC adaptor, open a hole at the relevant position on the soft case by using scissors or a similar object.

5. Operations and Functions

5.1. Power ON/OFF

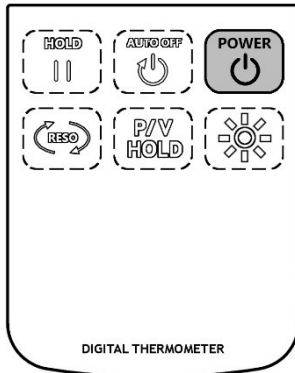

Pressing the **POWER** key will illuminate all the indicators for about three seconds and start measurements. Press the **POWER** key again to turn the instrument off.

All illuminated

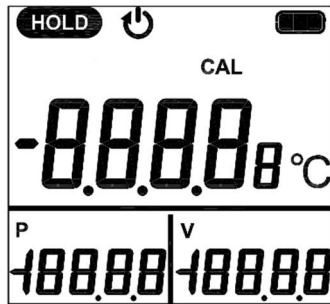

Automatic correction function ON/OFF



5.2. Automatic correction function

When the instrument is switched on with the probe with the IC tag (BSM Series/BUM Series/SFM Series) connected, CAL flashes and the instrument turns on the Automatic correction function. This mode enables a high accuracy measurement at a resolution of 0.01°C. Turning on the device with any other type of probe will turn off CAL and turn off the Automatic correction function feature.

Note: If CAL does not blink, turn on the power again.

Automatic correction function OFF

(CAL not illuminated)



Other probes

All illuminated



Dedicated probe

Automatic correction function ON

(CAL flashing)



5.3. HOLD Function

Press the **HOLD** key to maintain the indicated values during measurements. HOLD will illuminate on the screen while HOLD is on. To release the HOLD function, press the **HOLD** key again.

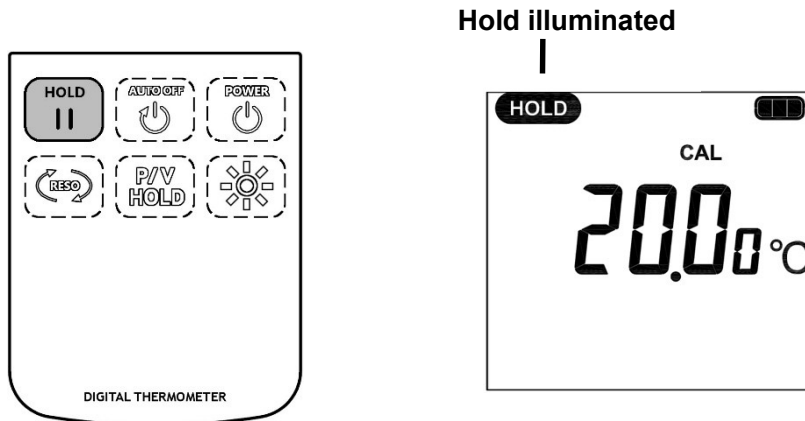

Notes:

- Use the functions below after releasing the HOLD function and P/V Hold function.
- The HOLD function cannot be used while burnout or overrange is displayed.

5.4. Automatic Power OFF Function

When the **AUTO OFF** key is pressed, “AUTO OFF” symbol will illuminate on the screen. If no key operation is performed for a certain period of time (about five minutes), the power will automatically be turned off, preventing the unit from remaining turned on. To release the Automatic Power OFF function, press the **AUTO OFF** key again.

- Please use the following functions after canceling the hold function and P/V hold function.
- The hold function cannot be used during burnout or overrange display.

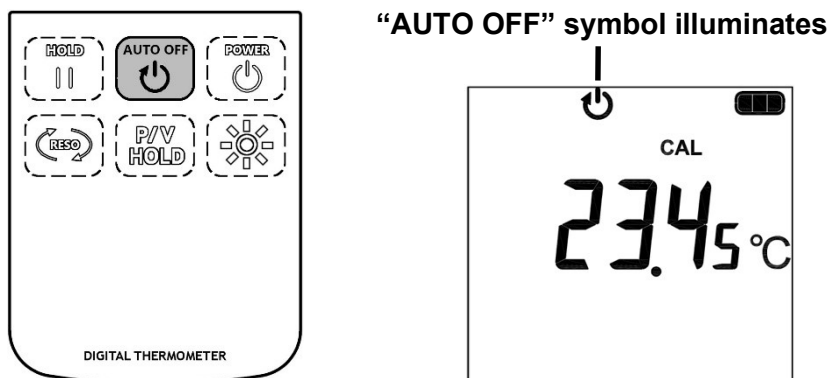

5.5. Resolution Change

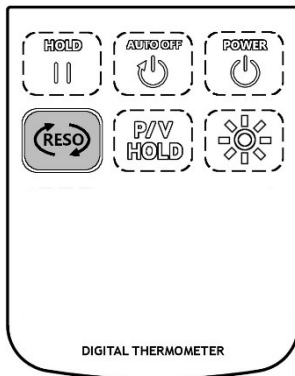

Press the **RESO** key to switch the resolution.

- 0.01°C resolution indication: The range between -104.99 and 199.99°C is displayed with the 0.01°C resolution. When the temperature goes out of this range, it will automatically be displayed with the 0.1°C resolution.
- 0.1°C resolution indication: The 0.1°C resolution indication is applied to all the range.

Note: Resolutions cannot be switched with the following functions: P/V Hold function, Burnout indication, and Overrange indication.

0.01°C resolution indication



0.1°C resolution indication



5.6. P/V Hold Function

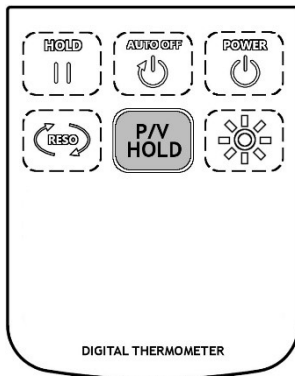

Press the **P/V-HOLD** key to enter the P/V Hold function. The lowest and highest values will be displayed in the sub-screens. Press the **P/V-HOLD** again to return to normal measurements.

Normal measurement



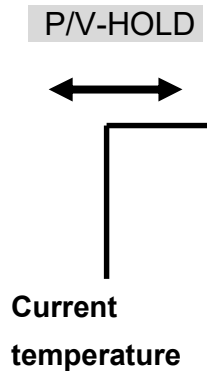
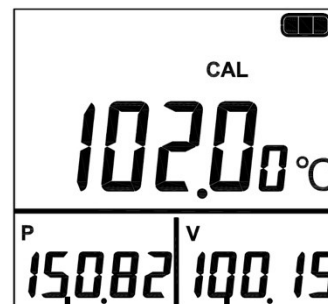

P/V mode

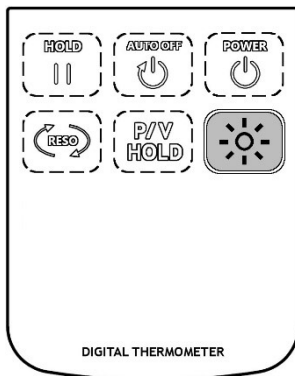

Max. value Min. value

5.7. Turning the Backlight ON/OFF



Press the  key to turn on the backlight so that indications on the screen can be seen in dark places. Press the  key again to turn off the backlight.

Note: When the backlight is ON, more battery usage will be incurred. Don't forget to turn it off.

6. Retention of Setup Data

Some settings will be released when the batteries are exchanged or when the instrument is turned off. Please check the details in the following table:

Function	
HOLD	Released
Automatic power OFF	Retained
P/V hold	Released
Resolution	Released
Backlight	Released

7. Checking the Remaining Battery

Remaining battery is displayed in the top right corner of the indication.

The remaining battery shows the continuous time of use in the rate shown in the table below.

As properties vary, depending on batteries, use this value only as a reference.

Remaining battery indication

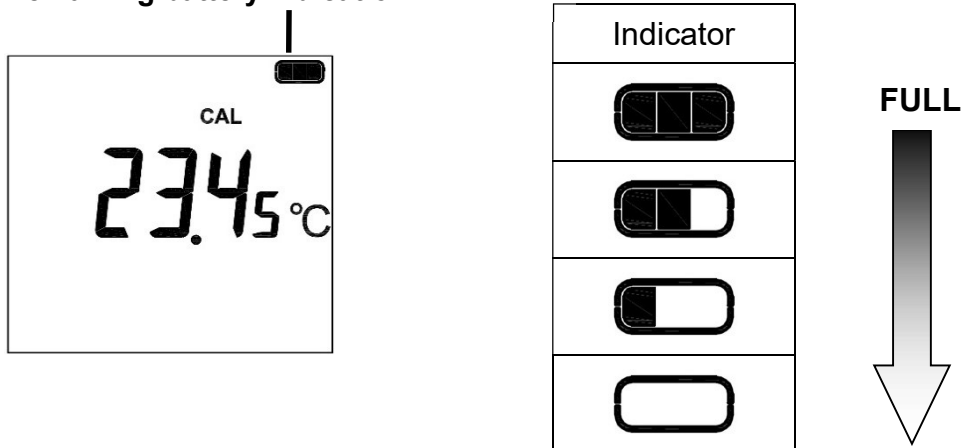

When the indication of the indicator becomes , replace the batteries with new ones.

8. Error Messages

8.1. Indication of a Broken Wire of the Probe



If the probe has a broken wire or is disconnected, the burnout (broken wire) indication is displayed.

If this indication is displayed, replace the probe with a new one or connect the probe.

8.2. Overrange Indication



When the temperature in measurement exceeds the measurable range, the overrange indication is displayed.

- If the wire of the probe is about to become broken, this overrange indication may be shown. If it is clear that the temperature in measurement is within the measurable range, check the probe.



- Even if the overrange indication is shown, it will not damage the instrument. However, the probe may be consumed, so relocate it to a place where the temperature is at a heat-resistant temperature or a lower temperature.

8.3. Battery Voltage Drop Indication



When batteries are depleted and the battery indication on the screen becomes , replace the batteries with new ones.

9. Maintenance

9.1. Storage

When storing this instrument, avoid the following places:

- In direct sunlight
- Subject to heavy vibrations
- High humidity (85%RH or more)
- High temperature atmosphere (50°C or higher)
- Filled with dust, waste, corrosive gas and/or salt
- High electromagnetic field

To store the instrument for a long time, it is recommended to remove the batteries and store the unit in the original packaging at the time of delivery.

9.2. When the Case of the Instrument Gets Dirty

When the case of the instrument gets dirty, please wipe it with a slightly damp cloth. Do not use alcohol, thinner, benzene, or other chemicals. Otherwise, the case or keyboard may become discolored or deformed.

* About waterproofing

The simple water resistance specifications of this product are equivalent to IPX5. It can be washed with a small amount of water. However, do not directly spray water on the air hole near the battery storage housing.

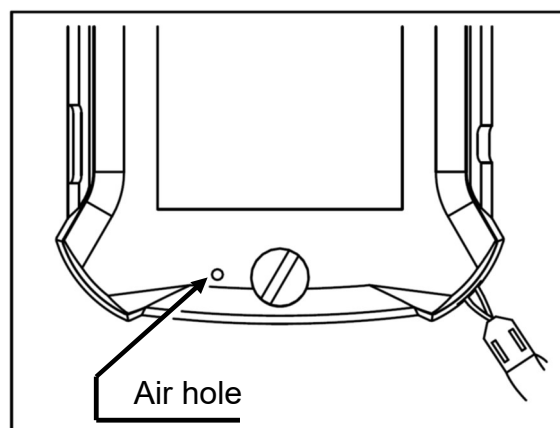

10. Troubleshooting: Before Contacting Support

If you find any abnormalities or become unable to operate the instrument, first check for the following items. If you still cannot solve the issue, please contact your retailer or our company.

(1) The instrument does not operate when the power is turned on:

- Is the orientation of the batteries in the correct manner?

Reset the batteries.

- Have the batteries been depleted?

Install new batteries.

(2) The indicated values of temperature are unstable:

- Is the wire of the probe almost broken or is the probe deformed?

Do an appearance check of the probe.

- Is the probe connector inserted fully?

Re-insert the connector.

- Is the probe sufficiently making contact with the object of measurements?

Change how to set the probe.

- Is the measurement environment in a high electromagnetic field (such as a large motor)?

- Relocate the instrument or use the shield.

(3) If measurement errors are too large:

- Are the thermocouple types of the probe and this instrument the same?

Replace the probe.

- Is the head of the probe deformed?

Replace it with a new one.

(4) Keys are not responding:

- Is there any burn out (broken wire) indication shown?

Set the probe.

- Are any functions running?

Terminate various functions and retry to operate the keys.

11. HRM-120E Specifications

ASP specifications

Model (HRM-)		120	
Operation switches		Membrane keyboard (with clicking function)	
Input connector		ASP connector (thermocouple homogeneous metals)	
Input		Thermocouple Type E or K	
No. of input		One	
Signal source resistance		1 k Ω or less	
Measurement range		0.1°C resolution	-104.9 to 204.9°C
		0.01°C resolution	-104.99 to 199.99°C
Measurement accuracy	0.1°C resolution	-104.9 to 204.9°C	$\pm 0.1^\circ\text{C}$
	0.01°C resolution	-104.99 to 199.99°C	$\pm 0.10^\circ\text{C}$
Accuracy of reference junction compensation			$\pm 0.10^\circ\text{C}$ (at $25^\circ\text{C} \pm 10^\circ\text{C}$)
Temperature coefficient (Only when exceeding $25^\circ\text{C} \pm 10^\circ\text{C}$)			$\pm 0.005 \times \Delta t^\circ\text{C}$ (Exceeded temperature Δt is multiplied by the coefficient and then added to the indication tolerance (measurement accuracy + accuracy of the reference junction compensation)) Ex. @ 50°C or 0°C environment: $\pm 0.075^\circ\text{C}$ added
Operational conditions			0 to 50°C , within 0 to 80% RH (no condensation)
Storage conditions			-20 to 50°C , within 0 to 85% RH (no condensation)
Sampling frequency			About 500 ms
Linearizer method			Digital linearizer method (compliant with JIS C 1602-2015)
Dimensions			$82.1 \times 166 \times 36$ mm(W \times H \times D) (Excluding connector extrusion)
Weight			About 350 g (including batteries)

	Power supply	See “ Specifications (power supply)”.
	Accessories	See “ Specifications (accessories)”.
RFID	Frequency	13.56MHz
	Type of Modulation	ASK
	Number of channels	1
	Maximum field strength	23.05dB μ V/m (Peak) @30m
	Compliant standard	Standard #: ARIB STD-T82 Type designation #: FC-20001 Standard #: CCAQ23LP0671T2 Standard #: ETSI EN 300 330

Notes:

- For probe resolution, please refer to individual probe specifications.
- Use the product when the temperature of the plug and the instrument reach room temperature.

* About the tolerance

The indication tolerance on the main unit of the thermometer is calculated as “measurement accuracy + accuracy of reference junction compensation”. However, this product is manufactured by customizing the reference junction compensation section for individual products. For this reason, the acceptance-rejection criterion at the time of shipment does not take the accuracy of the reference junction compensation into account and makes judgment for the measurement accuracy only. (This will narrow tolerance. The same applies to 0.01°C resolution. IC tags without correction are used for inspection.)

For actual use, please calculate the indication tolerance with the formula: measurement accuracy + accuracy of reference junction compensation.

If the value exceeds 25°C±10°C, the formula will be: measurement accuracy + accuracy of reference junction compensation + temperature coefficient.

Specifications (power supply)

Model (HRM-)	120
Batteries	4 x Alkaline AA battery (LR6)
Battery life (continuous operation time)	About 600h

* Lithium batteries are not used.

Specifications (accessories)

Common	Instruction manual
	Test report
	Warranty sheet
	Soft case
	Hand strap
	4 x Alkaline AA battery (LR6)

Jan. 2024 First edition AE-100301